



K9 Partner

Power Door Opener



814 PowerTouch Remote Control Receiver
With Two Key Chain Transmitters and
Shown With Optional Oval Transmitter

**Please read entire instruction manual *prior* to starting the
K9 Partner Power Door Opener System Installation.**

Special Features and Applications

Easy to Open

Unlatch and open door - at the touch of a button.

Optional Transmitters

Large transmitters with large buttons can be ordered.

Extra Channels

Two extra channels are available at no extra cost to unlock other doors.

Range

Typical antenna range is 60-feet. Range can be increased using an optional external antenna.

Included

Proximity switch installed to disable ground to door unlatch motor.

Contents, Installation Tools, Technical Support

Contents

Special Features and Applications	Page 1
Contents, Installation Tools, Technical Support	Page 2
Specifications	Page 3
Component Parts List	Page 4, 5
Operation: K9 Partner Remote Control	Page 6
Installation: Planning	Page 6, 7
Installation: Actuator & Linkage Rod	Page 8
Installation: Gas Strut	Page 9
Installation: Electrical - Receiver Power & Ground	Page 10
Installation: Electrical - Door Open Circuit	Page 11
Installation: Safety Disable Switch	Page 12
Installation: Electrical - Door Unlock / Lock Circuit	Page 12, 13
Installation: Final Test	Page 14
Trouble Shooting Guide	Page 15, 16, 17, 18, 19
Limited One (1) Year Warranty	Page 20

Installation Tools

Voltmeter, analog or digital	Hand Drill
Phillips Screw Driver	Assorted Drill Bits
Adjustable Wrench	Needle Nose Pliers
Screw Driver	Wire / Connector Crimping Tool
Diagonal Wire Cutter	Wire Stripper

To Clean Grounding Pad:

Scraper, Sand Paper, Alcohol Based Cleaner

Technical Support

Visit the factory website to download a copy of these instructions, e-mail technical questions and see other TouchTronics, Inc. products.

TouchTronics, Inc. Phone / Fax Numbers

Indiana Local	1-574-294-2570
Toll Free	1-800-294-2570
Fax	1-574-293-1611

TouchTronics, Inc. Web Site

www.touchtronics.com

TouchTronics, Inc. E-Mail

Customer Service	touchtronics@touchtronics.com
Technical Support	techsupport@touchtronics.com
Or	'Contact Request' link on the web page

Galls, Inc. Phone / Fax Numbers

Customer Service / USA	1-800-477-7766
Customer Service / Canada, PR, US-VI	1-888-733-5391
Customer Service / Other	1-859-266-7227
Fax / USA	1-800-944-2557
Fax / Other	1-859-269-4360

Galls Inc. Web Site

www.galls.com

Galls, Inc. E-Mail

















Customer Service	help-desk@galls.com
Technical Support	tech-support@galls.com

Specifications

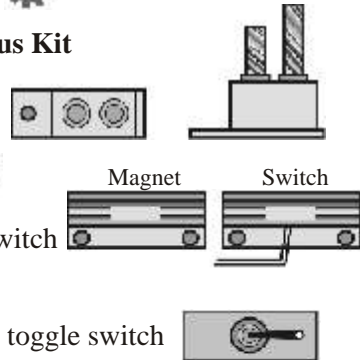
814 Receiver:	FCC Approved
RF System	6561 Digital Codes
Voltage	12 Volt DC (available in 24 Volt DC)
Output	300mA
Frequency	303 MHz
Range	60 Feet (typical - using standard 36" grey, wire style, antenna)
Note:	Range may be extended with an externally mounted antenna
814 Transmitter:	FCC Approved
RF System	6561 Digital Codes
Battery	12 Volt DC
Cycles	32,400 One Second Pulses
Frequency	303 MHz
Note:	Key chain style transmitters are water resistant, NOT water proof Oval style transmitters are water and dust resistant
Physical:	
Receiver:	3" x 1" x 2" (width, height, depth)
Transmitter:	1 1/2" x 2" (width, length) key chain style 2" x 4 1/2" (width, length) oval(hand held) style
Gas Strut:	
Force	30 lbs
Expanded Length	24"
Compressed Length	14"
Relay:	
Type	Form C, SPDT
Coil Current	100mA
Switching Current	30 A
Coil Voltage	12vdc
Actuator:	
Type	Push-Pull Clutch Motor
Force	50 Newtons (approx 4-5 lbs of force)
Voltage	12vdc
Circuit Breaker:	
Type	Auto Reset
Current	10 A
Voltage	12vdc
Proximity Switch:	
Magnets Together	Normally Closed (N.C.)
Magnets Apart	Normally Open (N.O.)
Current	0.5 A
Voltage	12vdc
Toggle Switch:	
Type	SPST, On/Off Latching
Red Status Light	On
Current	30 A
Voltage	12vdc

Estimated Installation time for Complete Kit is 4 - 8 hours

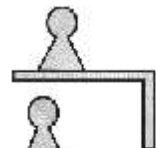
Component Parts List

- | | | | |
|----------|--|--|---|
| 1) | 1 kit 8144M/2 | 814 PowerTouch Remote Control System |  |
| | 1pc 814R | RF Receiver, 4 Channel w/36" antenna wire | |
| | 1 set 814H | Harness - 8 wire, 9" |  |
| | 2 pcs 814T3 | Transmitter,
3 button key chain style |  |
| 2) | 1 pc S840.B1 | Belt Loop Holder, for key chain style transmitter |  |
| Optional | 814T4XS
S840.B2 | Transmitter, 4 button oval (hand held) style
Belt loop holder, for oval style transmitter |  |
| | (Must send in one or both small transmitters to be reworked into large Handheld transmitters. Call your Galls representative for current pricing.) | | |
| 3) | 1 kit S840.F1 | K9 Door Opener - Fastener Kit | |
| | 7 pcs SCW.7001 | 10 x 3/4" self drilling screw |  |
| | 9 pcs TRM.8014 | 16g blue, butt connector |  |
| | 1 pc TRM.8010 | 18g red, 0.250 male quick connect |  |
| | 3 pcs TRM.8001 | 18g red, 3/16" ring terminal |  |
| | 1 pc TRM.8002 | 12g yellow, 5/16" ring terminal |  |
| | 1 pc WSH.9000 | 3/16" external tooth star washer |  |
| 4) | 1 kit S840.M1 | K9 Door Opener - Miscellaneous Kit |  |
| | 1 pc BRK.AT10A | 10 amp auto reset circuit breaker |  |
| | 2 pcs NTS.6000 | 10-32 machine screw nut |  |
| | 1 pc SWS.MG08 | On/Off, panel mount magnetic switch |  |
| | 1 pc SWS.TG18 | On/Off, panel mount, red lighted toggle switch |  |
| 5) | 1 kit S840.M2 | K9 Door Opener - Door and Floor Bracket Kit | |
| | 1 pc C840.B1 | Metal door bracket |  |
| | 1 pc C840.B2 | Metal floor bracket |  |

Component Parts List

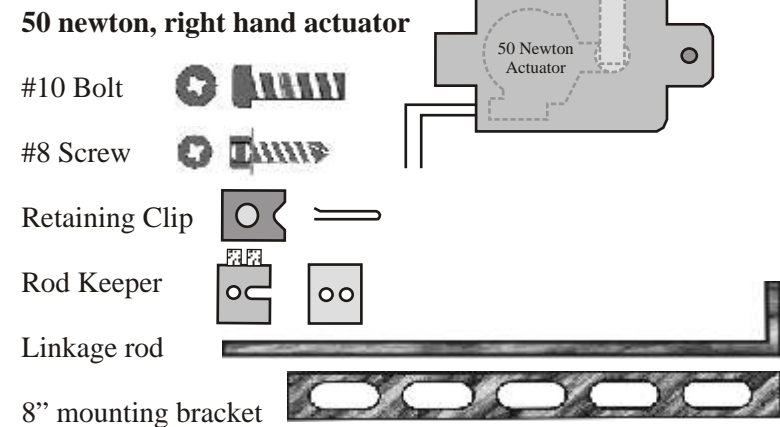
- | | | | | |
|----|--------------|-------------------|---------------------------------------|--|
| 6) | 1 kit | ACT.50N.RH | 50 newton, right hand actuator |  |
| | 1pc | BLT.840ACT | #10 Bolt | |
| | 2pcs | SCW.840ACT | #8 Screw | |
| | 1pc | CLP.840ACT | Retaining Clip | |
| | 1pc | KPR.840ACT | Rod Keeper | |
| | 1pc | ROD.840ACT | Linkage rod | |
| | 1pc | BKT.840ACT | 8" mounting bracket | |

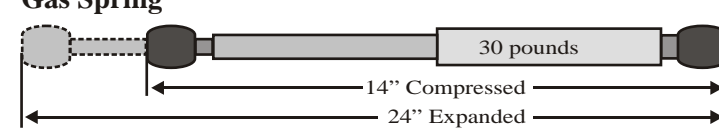
- | | | | |
|----|-------------|-----------------------|--|
| 7) | 1 pc | GSS.SE1000V30P | Gas Spring |
| | | |  |

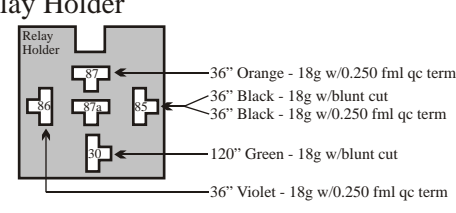
- | | | | |
|----|------------------|----------------|---|
| 8) | 1 harness | C840.H1 | K9 door opener harness |
| | 1 pc | Relay Holder | Standard Automotive Relay Holder |
| | 1 pc | Orange Wire | 36", 18g, Terminal 87 |
| | 1 pc | Black Wire | 36", 18g, Terminal 85 |
| | 1 pc | Black Wire | 36", 18g, Terminal 85 |
| | | Empty | Empty - Terminal 87a |
| | 1 pc | Violet Wire | 36", 18g, Terminal 86 |
| | 1 pc | Green Wire | 120", 18g, Terminal 30 |
| | | |  |

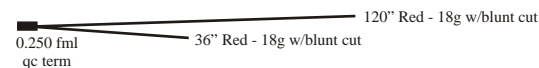
- | | | | |
|-----|------|----------|--|
| 8a) | 1 pc | Red Wire | 120", 18g |
| | 1 pc | Red Wire | 36", 18g |
| | | |  |

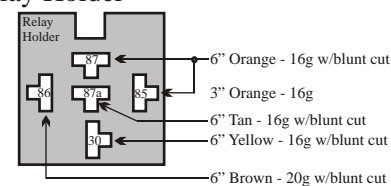
- | | | | |
|----|------------------|----------------|--|
| 9) | 1 harness | C840.H2 | Door lock relay holder harness |
| | 1 pc | Relay Holder | Standard Automotive Relay Holder |
| | 1 pc | Orange Wire | 6", 16g, Terminal 87 |
| | 1 pc | Orange Wire | 3", 16g, Terminal 85 |
| | 1 pc | Tan Wire | 6", 16g, Terminal 87a |
| | 1 pc | Brown Wire | 6", 20g, Terminal 86 |
| | 1 pc | Yellow Wire | 6", 16g, Terminal 30 |
| | | |  |

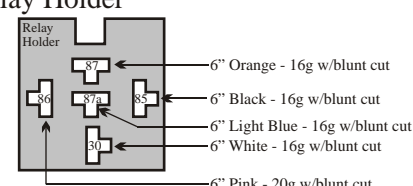
- | | | | |
|-----|------------------|----------------|--|
| 10) | 1 harness | C840.H3 | Door unlock relay holder harness |
| | 1 pc | Relay Holder | Standard Automotive Relay Holder |
| | 1 pc | Orange Wire | 6", 16g, Terminal 87 |
| | 1 pc | Black Wire | 6", 16g, Terminal 85 |
| | 1 pc | Lt Blue Wire | 6", 16g, Terminal 87a |
| | 1 pc | Pink Wire | 6", 20g, Terminal 86 |
| | 1 pc | White Wire | 6", 16g, Terminal 30 |
| | | |  |

- | | | | |
|-----|--------------|----------------------|---|
| 11) | 3 pcs | RLY.Q30A12V.C | 30 a, 12vdc, spdt, automotive relay |
| | | |  |

- | | | | |
|-----|-------------|----------------|---|
| 12) | 1 pc | C814.L1 | Do Not Engage Child Safety Switch Label
(Place over safety lock on door used by k9) |
|-----|-------------|----------------|---|



Operation: K9 Partner Remote Control

Unlocking Rear Door

Press button "A" to unlock rear door. When the radio frequency (RF) signal is received by the receiver, the relay (supplied) energizes the factory electric door lock mechanism and then unlocks the door.

Opening Rear Door

Press button "B" to open the rear door. When the radio frequency (RF) signal is received by the receiver, the actuator (supplied) unlatches the rear door, the gas strut pushes the door open 10 to 20 inches to allow the K9 to exit the vehicle.

Locking Rear Door

Press both buttons together to lock the rear door. The radio frequency (RF) signal is received by the receiver, the relay (supplied) energizes the factory electric door lock mechanism and then locks the door.

Interference Warning

All RF signals are subject to **INTERFERENCE** - including but NOT limited to: other RF antennas, other RF signals being broadcast at the same time, other RF devices (radios, radar devices), large pieces of metal or metal buildings, large bundles of wire (inside a vehicle), switching power supplies, and motors of any kind.

The RF signal can pass through obstacles in the line of sight such as; wood, glass or plastic. RF signals cannot pass through any type of metal or tinted windows which have been tinted with a metalized film. All factory tinting & some aftermarket tinting use the metalized film technology.

Installation: Planning

Test lights can cause vehicle computer damage if the wrong wires are probed and can cause the air bag systems to activate (deploy). Pay close attention to all caution labels in the vehicle. TouchTronics, Inc., will assume absolutely **NO** responsibility whatsoever for this, or any other damage done to the vehicle, or any personal injury due to improper installation. Refer to the limited warranty for details.

WARNING!
Use ONLY a volt meter to check voltage
during installation and testing.
**Using a test light WILL damage the outputs!*



1) Receiver Output Voltages

- A) The receiver has four output voltages (channels) which will operate four separate circuits. The output voltage is 12 volts direct current (vdc). The maximum drive current for each of the four output channels is 300mA (maximum). The four outputs can (drive) turn On small bulbs or relay coils.
- B) Check the power requirement for the relay before connecting to the receiver. The relay coil should be rated for the current requirements. The maximum allowable coil current is 300mA.

2) Select Receiver & Antenna Mounting Location

- A) Typically the receiver is mounted under the dash, as high up as possible and away from any bundled wires, other RF devices or switching power supplies. **DO NOT** mount behind any metal or tinted windows. **DO NOT** install the receiver unit under the hood of the vehicle or in the door as the receiver is NOT water proof. Water damage will NOT be covered under the warranty.
- B) The antenna wire is the long grey 36" wire on the back side of the receiver housing. The antenna should be mounted so that at least twelve inches (12") is exposed in a window or dash, as high up as possible. The antenna should NOT touch any metal or window tinting, nor be mounted near any other RF devices, any bundled wires or other antennas. RF signals from base radios can overwhelm the RF signal from the transmitter to the receiver and cause a decrease in range and/or a slow response time.
- C) Select a chassis ground location that **DOES NOT HAVE ANY OTHER** grounds attached to it, as a ground loop or signal back feed can occur.
- D) **DO NOT mount the receiver and antenna:**
 - 1) Within 6 feet of a motor
 - 2) Near large bundles of wires
 - 3) Near other antennas or RF devices
 - 4) Switching power supplies
 - 5) The antenna should not be touching any metal as this grounds the RF (radio frequency) signal

Installation: Planning, Continued

On/Off Toggle Switch

Select a place on the dash or console that is easily accessible and easily visible so that the status indicator light on the switch may be seen.

Door Latch Actuator

Remove the door panel and locate the door latch. Select a mounting location that will allow the actuator to push or pull in a straight line. If the actuator movement is not straight (linear) the actuator will bind and fail. Many newer SUV's and standard vehicles have changed the latch designs, making them more difficult to open electrically. Often you will need a mechanical advantage to open the door such as a lever or external spring. See diagrams on page 8.

Gas Strut

Check the floor and the exposed door frame to locate a suitable location to install the special door and floor bracket. The surface must be strong, stable and should NOT flex. The strut must be mounted so that the hydraulic fluid inside will lubricate the piston. See diagrams on page 9.

Factory Door Lock

Vehicle door lock circuits are factory designed as positive pulse, negative pulse or reversal rest @ ground circuits. Determine which type of door lock circuit is used in your vehicle.

Positive Pulse System: The switch has 3 wires. The input terminal, usually the center terminal, is +12v. When the switch knob is pressed (momentarily On) one of the other terminals is also +12v. This means that the switch is sending a +12v (positive pulse) signal to lock or unlock the door. There is a special relay in this circuit which handles the 'reversal rest @ ground' circuit required for most motor operations. Most GM vehicles use a Positive Pulse circuit for door locks. Check the number of wires on the switch and check the input wire to the switch. It should be a +12v signal. See diagram pg 13.

Negative Pulse System: The switch has 3 wires. The input terminal, usually the center terminal, is ground. When the switch knob is pressed (momentarily On) one of the other terminals is also ground. This means that the switch is sending a ground (negative pulse) signal to lock or unlock the door. There is a special relay in this circuit which handles the 'reversal rest @ ground' circuit required for most motor operations. Most foreign cars use a Negative Pulse circuit for the door locks. Check the number of wires on the switch and check the input wire to the switch. It should be a ground signal. See diagram pg 13.

Reversal Rest @ Ground System: This switch usually has 5 wires (sometimes 4 wires). All of the wires and terminals rest @ 'ground' when the switch is not activated. One terminal becomes +12v (positive) only when the switch is activated. The switch sends a positive signal through the system and turns on the motor. The ground signal from the motor passes through the other side of the switch and goes to a chassis ground. There is no special relay in this circuit because the switches are hard-wired to handle the high current of the 'reversal rest @ ground' circuit required for most motor operations. Most Ford vehicles and most Chrysler vehicles use a Reversal Rest @ Ground circuit for door locks. Check the number of wires on the switch. If there are 4 or 5 wires, then the circuit is probably a reversal rest @ ground circuit. See diagram pg 13

To determine which type is used in your vehicle, take a voltmeter and probe one of the output wires at the switch. Check the polarity with the switch pressed and without the switch pressed. Compare results with the chart below.

Door Lock Switch	Output Terminals		3 of Terminals	Current
	Switch NOT Pressed	Switch Pressed	Typical # of Wires	
Positive Pulse	No Voltage / Floats	+12 Volts	3 Wires	1 amp
Negative Pulse	No Voltage / Floats	Ground	3 Wires	1 amp
Reversal Rest@Ground	Ground	+12 Volts	5 Wires	20 amps

Installation: Actuator and Linkage Rod

- 1) Locate the Door Latch Linkage Rod
- 2) Select mounting location for actuator. *Note: Actuator Rod MUST move in a linear (straight) direction, or parallel to the linkage rod.
- 3) Install the actuator rod into the plastic clip on actuator. (Diagram 8d) The bent end of the rod is pressed into the plastic clip. To decrease the distance of the pull, the plastic clip can be moved to the second hole.
- 4) Bend the rod to make the adjustment required to achieve a straight or linear pull of the actuator. ***This is a critical adjustment to prevent binding and eventual failure of the actuator.***
- 5) Install the Rod Keeper Bracket on the rod. (Diagram 8a) Adjust location of rod keeper bracket to correct position for mounting door latch linkage rod. Tighten both allen screws.

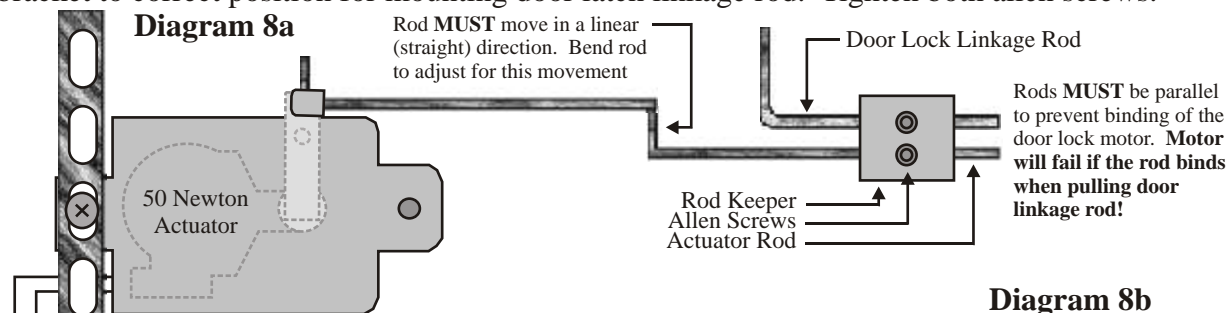

Notes:

- 1) Mount rod & plastic clip toward outside metal door skin. Diagram 8c
- 2) Mount actuator using bolts or screws and bracket. Each vehicle will have a different mounting location.
- 3) The direction of the actuator pull can be reversed by reversing the polarity of the green and blue wires.
- 4) Tighten both allen screws on the rod keeper securely

Diagram 8b

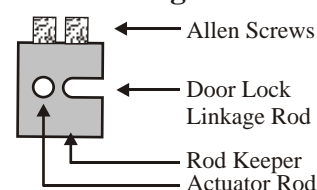

Diagram 8c

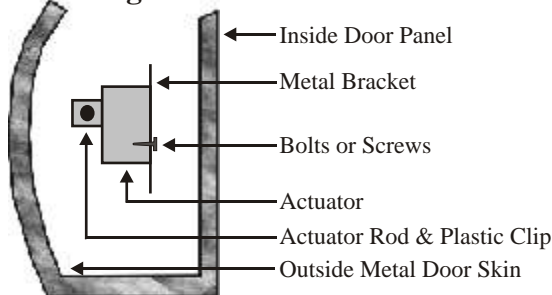
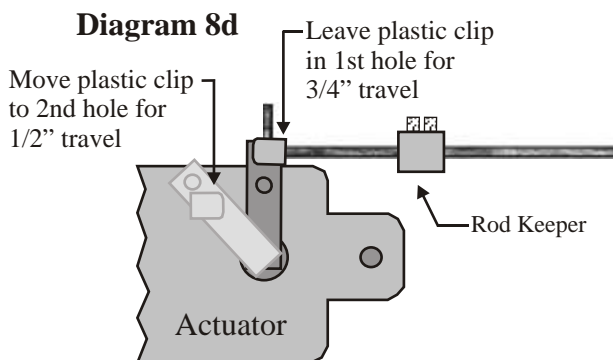
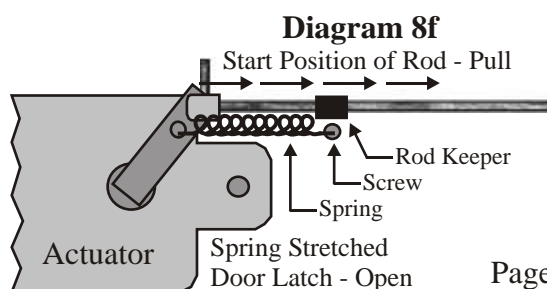
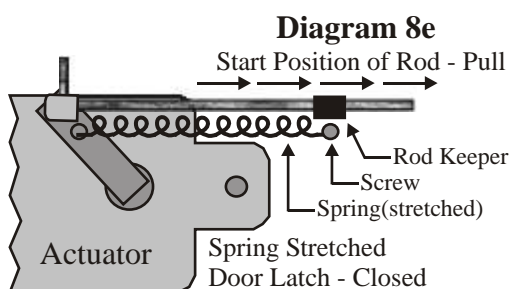

Diagram 8d



Note: Some vehicle door latches are more difficult to open than others. This is due to different manufacturing tolerances, age and wear on vehicle. To enhance the pulling power of the actuator, you can add springs, which can be purchased at a local hardware store. The spring must have enough force to assist the actuator when pulling the latch open, but not be so strong as to keep the latch from closing properly.



Installation: Gas Strut

Cross Section Top View Diagram 9a
Door Closed

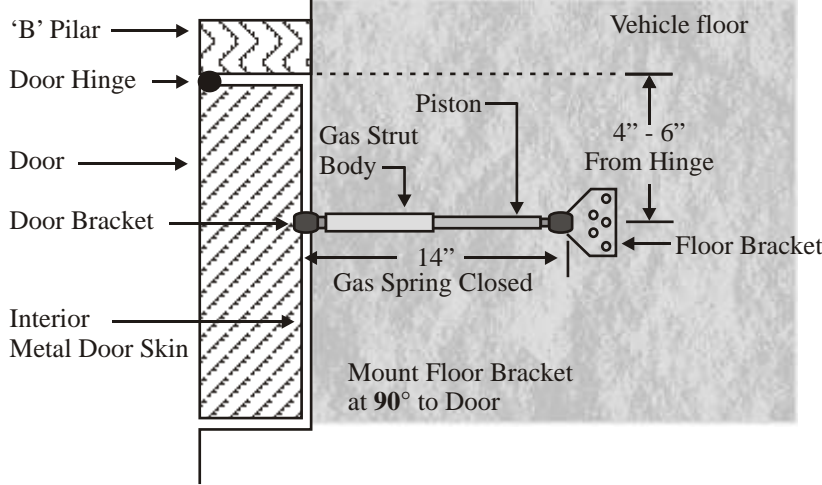

Side View Diagram 9b
Door & Floor Brackets

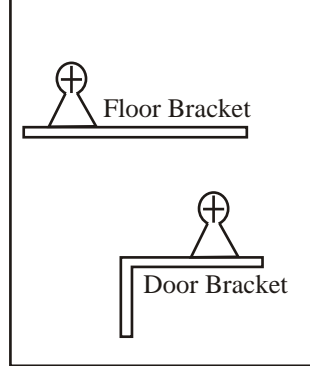

Cross Section Top View Diagram 9c
Door Open

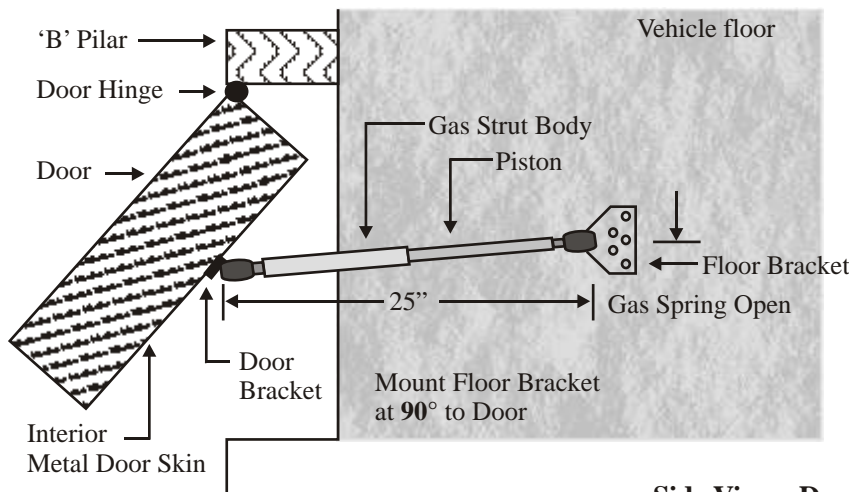

Notes:

- 1) **Body** of gas spring must be attached to the door.
- 2) **Piston** of gas spring should be in a downward position for best lubrication.

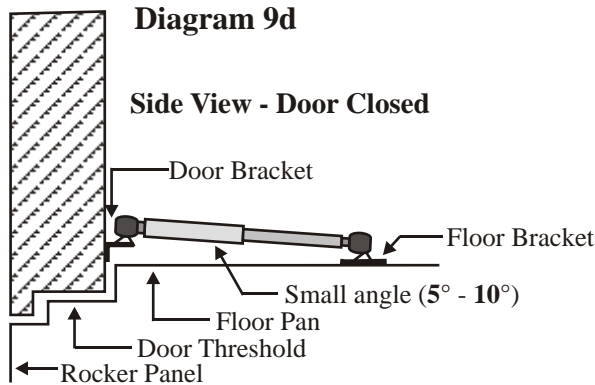

Side View - Door Open Diagram 9e

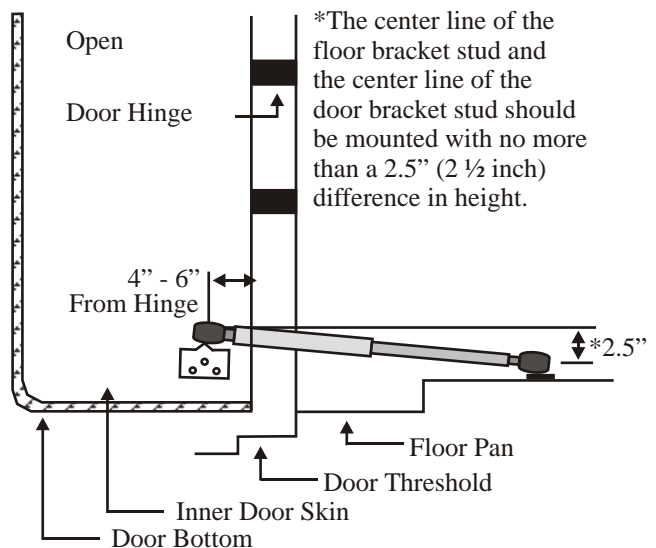

Installation: Electrical - Receiver Power & Ground

WARNING:

Disconnect the main battery power of the vehicle before starting installation of this system.

1) Install Power

Connect the Red wire to a constant +12v battery power source. Note: For best performance, run a clean +12v directly from the battery or a fuse that is NOT supplying any power to motors, lights or other high current devices, with the noted exception of the actuator supplied in this kit.

2) Install Ground

Connect the Black wire to chassis ground

- A) Scrape all paint and grease away from the body frame.
- A loose chassis ground connection WILL cause intermittent operation of receiver.**
- B) Clean the area using an alcohol based cleaner to remove paint chips and grease.
- C) Crimp a #10, 3/16" ring terminal onto the black ground wire.
- D) Insert the ring terminal and a #10, 3/16" star washer over a 10x3/4" hex head, self-tapping ground screw.
- E) Tighten ground screw securely into clean frame area.

WARNING!

Use ONLY a volt meter to check voltage during installation and testing.

**Using a test light WILL damage the outputs!*



Diagram 10a

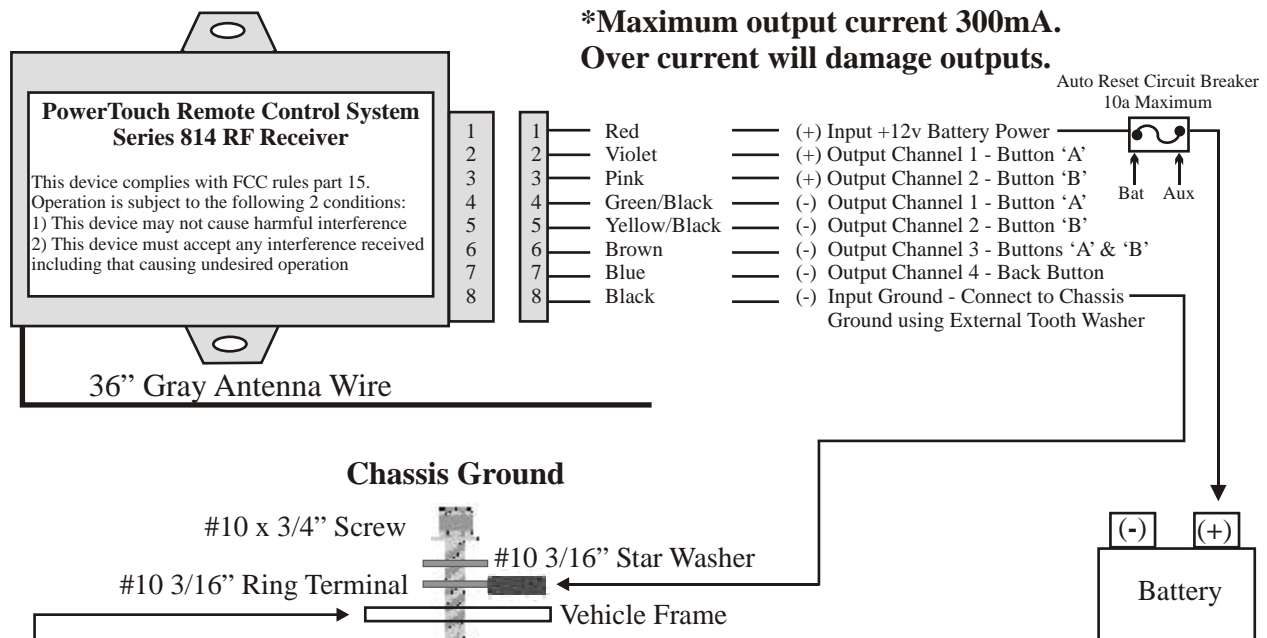

Scrape paint and clean area before installing ground screw.

A loose chassis ground connection WILL cause intermittent operation!

Installation: Electrical - Door Open Circuit

3) Install Door Open Circuit - Maximum output is 300mA

NOTE: Both button 'A' and 'B' can be wired so that either one will open the door.

- A) Connect the red power wire directly to the battery. See diagram 11b (18" red wire not supplied)
- B) Connect the other end of the power wire to the terminal marked battery on the circuit breaker.
- C) Connect the other terminal of the circuit breaker to the input terminal S2 (silver) of the toggle switch. See diagram 11a
- D) Connect the orange wire to terminal S1 (brass) on the toggle switch.
- E) Connect the other end of the orange wire to terminal #87 on the relay.
- F) Mount the relay near the receiver.
- G) Connect the pink wire to relay terminal #86.
- H) The other end of the pink wire is connected to the receiver channel 'B' output. (Channel 'A', violet wire, may also be used to open door.)
- I) Connect relay terminal #30, green wire, to the green wire on the actuator for pull. (Reverse wires to change actuator to push)
- J) Connect chassis ground for actuator motor using technique on page 10.
- K) Connect ground required to illuminate status bulb in switch to relay terminal #85 on relay. Run this ground through the proximity switch to disable motor when system is not active, switch is Off or vehicle is in gear.

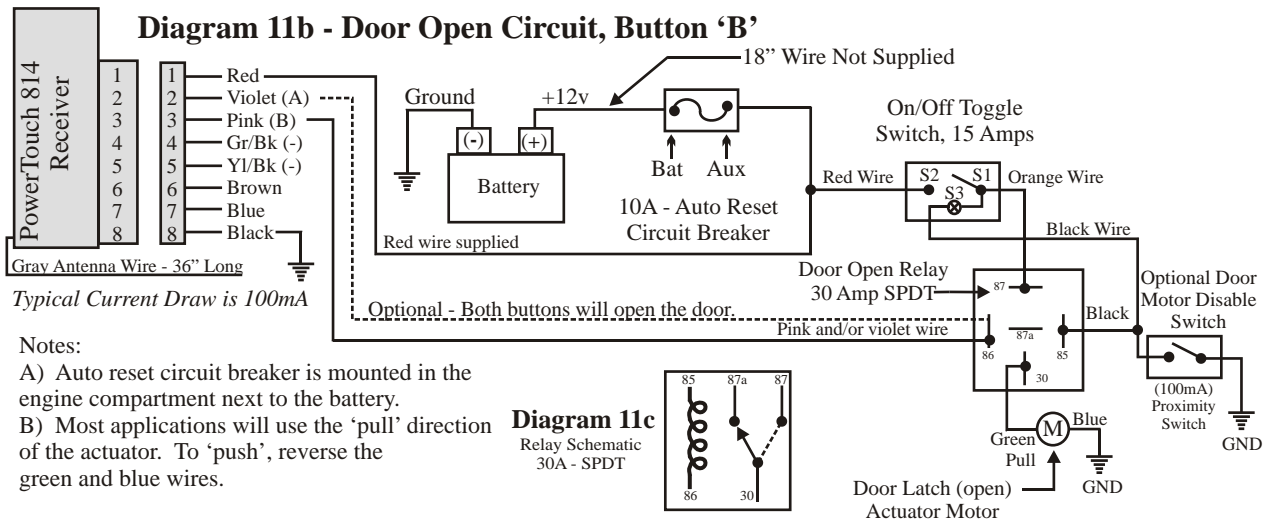
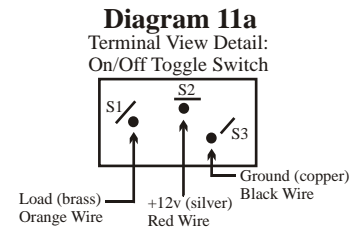

Notes:

- A) Auto reset circuit breaker is mounted in the engine compartment next to the battery.
- B) Most applications will use the 'pull' direction of the actuator. To 'push', reverse the green and blue wires.

4) Test mechanical and high current part of installation

- A) Turn power switch On.
- B) Unplug the connector from the receiver. Take a long wire (which has been stripped on both ends) and connect one end to the battery +12vdc, and touch the other end of wire to relay terminal #86. The relay should energize and the coil inside the relay should click. The output on terminal #30 is +12vdc and will activate the actuator. *Ensure the pull of the actuator is straight. If it is not straight, the actuator may bind and fail.
- C) Connect the door latch. Using the long wire that is still attached to the battery +12vdc, touch the other end of wire to relay terminal #86. The relay should energize and the coil inside the relay should click. The output on terminal #30 is +12vdc and will activate the actuator allowing the door latch to be pulled open. If the door does not open, check the length of the actuator pull travel. If the required travel length is more than 3/4", change the installation design to allow a lever or spring to assist. Actuators lose pulling force if the pull is over extended or more than 3/4".

WARNING!

If the receiver output wires are installed to the wrong polarity, the output will be damaged. For example: if the channel 2 pink (+12) output wire is connected to a ground, a 'dead short' will occur when the button is pressed. The output will test 'dead' and the trace may be burned or test 'high (On)' at all times.

Wiring Inspection

- A) Check all wiring connections visually
- B) Check the polarity of all wires
- C) Tape off or remove all unused wires.

Installation: Safety Disable Switch

WARNING! If using any type of motor, such as a window motor or a door lock motor - add a Disable switch to prevent the door or window circuit from operating when vehicle is in motion.

A disable switch should be installed in any application to deny operation of the motor when a vehicle is in motion. However, due to changes in automotive electrical design and the addition of computer controlled circuits, it is no longer advisable or safe to tap into or cut wires to disable automotive factory circuits. To overcome this problem, you must install an electro-mechanical switch which will determine gear position, thus safely disabling the circuit while the vehicle is in motion. Below are three options for installing a Safety Disable Switch.

Safety Disable Feature

Older models of Caprice and the Crown Victoria cars still have a Park/Neutral switch or output located near the steering column of the vehicle. However, many of the newer cars do not have an available output to sense the gear of the vehicle. The outputs that can sense the gear of the vehicle are logic level and directly connected to the computer, (ECM, Electronic Control Module). **If any wires or switches are attached to the ECM harness or computer outputs, the vehicle warranty may not be honored.**

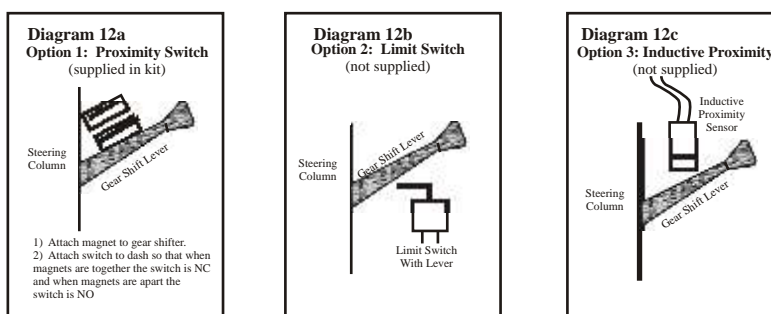

Installation: Electrical - Door Unlock / Lock Circuit

5) Install Door Lock Circuit

- Determine which type of door unlock circuit operates in the vehicle. See page 7 for a detailed explanation.
- Locate the lock and unlock wire color used in the vehicle. It is usually easiest to remove decorative panel around drivers switch and pop switch out of the door.
- Locate the switch and unlock motor in rear door.
- Determine if the wire colors in the switch match the wire color on the rear door lock motor for lock and unlock.
- CUT the wires between the rear door unlock switch and the rear door unlock motors. Choose a location that is easily serviced. (See diagram 13d)

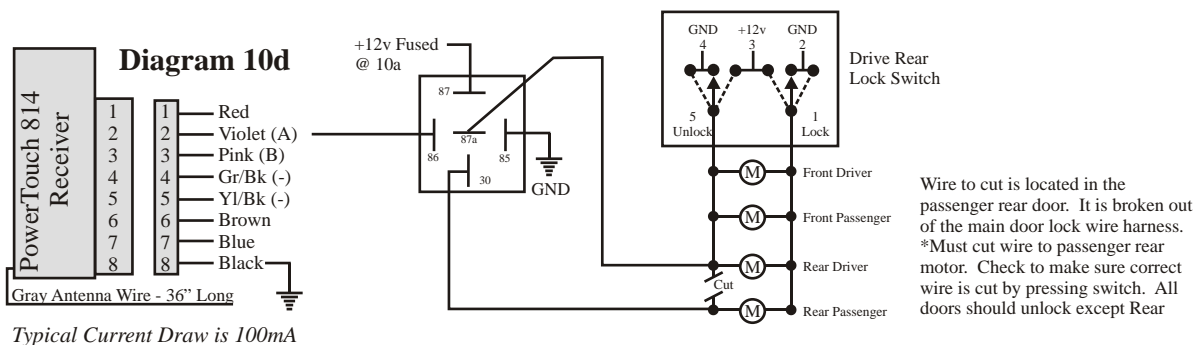

- Install a wire between relay terminal #87a and the cut wire going back to the switch.
- Install a wire between relay terminal #30 and the cut wire going to the motor.
- Reconnect power and test factory switch, then test button 'a' to verify proper unlocking of rear passenger door.

Installation: Electrical - Door Unlock / Lock Circuit

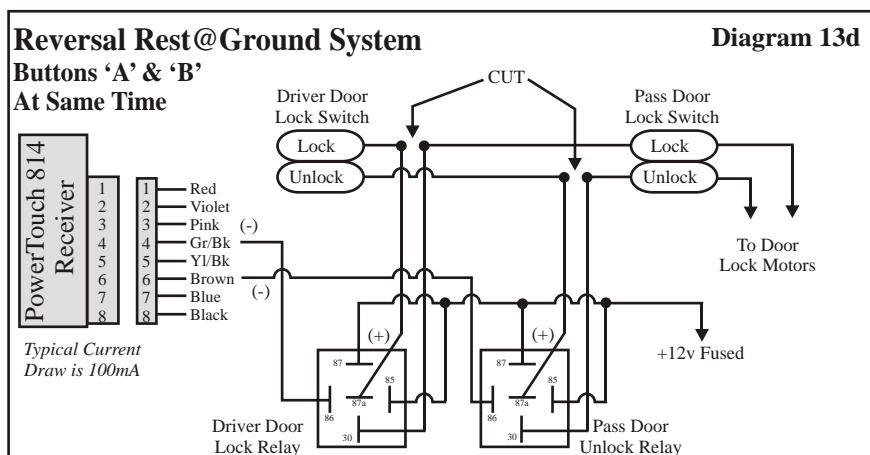
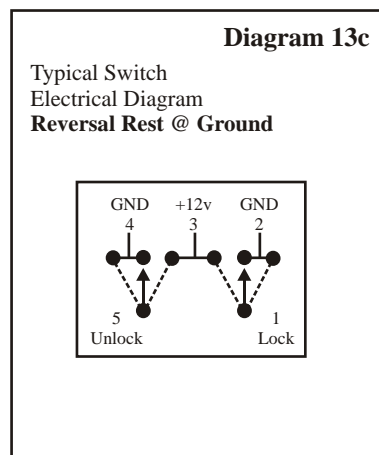
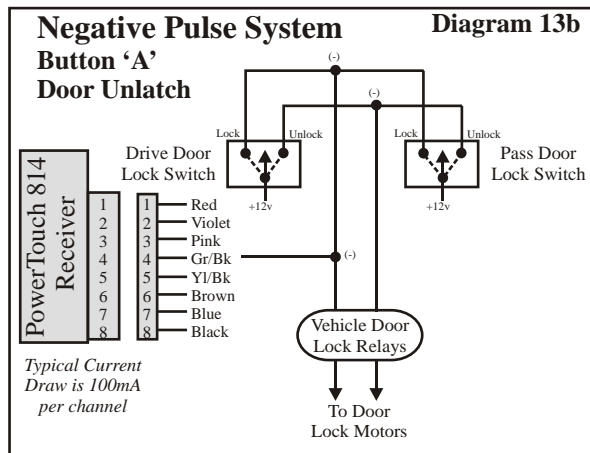
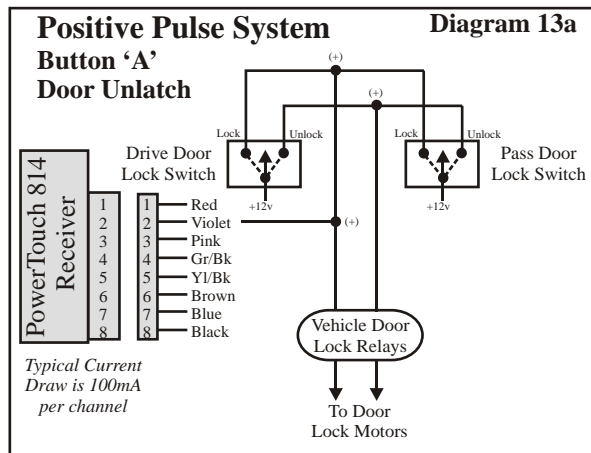

****Please Note:** Due to continually changing wire colors through-out the automotive industry, TouchTronics can NOT provide accurate wire color information on a consistent basis. Therefore, if the wire colors needed for installation are not known, please contact a local dealer and they should be able to provide any necessary information. Listed below are the currently known wire colors.

Vehicle	Year / Years	Unlock Wire Color	Lock Wire Color
Crown Victoria	1993 - 1999	Pink / Light Green	Pink / Yellow
Tahoe	1997 - 1998	Light Blue	White / Black or Black
Caprice	1993 - 1998	Light Blue	White / Black or Black
Jeep Grand Cherokee	1997 - 1998	Pink / Violet	Orange / Violet

Unlock / Lock Circuits used in vehicles:

Reversal Rest @ Ground - All wires are at a ground voltage until a switch is pressed, then the switched wire only is +12v. (1993 - 1998 Crown Victoria)

Positive Pulse Circuits - All wires are at a neutral voltage until a switch is pressed, then the switched wire becomes +12v. (1999 Crown Victoria & Chevy Caprice)

Installation: Final Test

- 1) Turn power toggle switch to Off
- 2) Replace battery power to vehicle
- 3) Power toggle switch should be Off - no red light
- 4) Test remote control buttons
 - a) Press remote control button 'A'
If connected to door unlock - All doors or rear door should unlock
 - b) Press remote control button 'B'
Door SHOULD NOT pop open
 - c) Press remote control buttons 'A' & 'B'
If connected to door lock - All doors or rear door should lock
- 5) Turn power toggle switch to ON
- 6) Test remote control buttons again
 - A) Press remote control button 'A'
If connected to door unlock - All doors or rear door should unlock
 - B) Press remote control button 'B'
Door SHOULD pop open
 - C) Press remote control buttons 'A' & 'B'
If connected to door lock - All doors or rear door should lock
- 7) Place vehicle in gear
 - A) Press remote control button 'B'
Door SHOULD NOT pop open

Check the trouble shooting guide to determine reasons for any failures.

Trouble Shooting Guide - K9 Partner Door Opener



**Use a digital or analog voltmeter to check power and voltage!
Do NOT use a test light**

Symptom	Possible Cause	Corrective Action
3.0 No power to remote control receiver	3.1 Logic ground or power connection to receiver has failed 3.2 Chassis ground connection has failed	3.1a Check logic ground (black wire) and logic power (red wire). Use a voltmeter probe when checking voltage. 3.1b If either ground or power is not present, then locate failure in wire harness and repair. 3.2a Check chassis ground connection, it should be clean and tight, no paint on metal, an external tooth star washer should be present, no rust or dirt in connection. 3.2b Chassis ground should be located on vehicle frame.
Symptom	Possible Cause	Corrective Action
4.0 No signal (code) being transmitted	4.1 Battery voltage low 4.2 Transmitter is not sending a signal 4.3 Transmitter code is incorrect 4.4 Not all buttons send a signal when pressed	4.1 Check battery voltage. Replace battery if voltage is 11.5 volts or less. (Signal strength is dependent upon battery voltage.) 4.2 Place probe from voltmeter on battery (+) and (-) leads. Press any button, voltage should change by 0.2 to 0.3 volts if a signal is transmitted. Check both buttons. 4.3a If transmitter is sending a signal and no signal is being received, re-code transmitter. 4.3b Send back to factory for re-coding. 4.4 If a signal is not transmitted on all buttons, send back to factory for repair or replacement.
Symptom	Possible Cause	Corrective Action
5.0 Poor range 0' to 25' (pulsating 0' to 25')	5.1 Antenna damaged or grounded	5.1a Check antenna placement, it should not be touching any metal or tinted glass. 5.1b It should not be closer than 6' to any motors or relays. 5.1c If it is coiled, then stretch it out and place near a window. 5.1d If antenna is cut or damaged, send back to factory for repair. 5.1e <i>NOTE: Antenna can NOT be shortened or altered in any way</i>

Trouble Shooting Guide - K9 Partner door Opener

Symptom	Possible Cause	Corrective Action
5.0 Poor range 0' to 25' (pulsating 0' to 25')	5.2 Receiver installed in poor locations such as near door or lift motor	5.2a Disconnect door and / or ramp motor and recheck range. 5.2b If range is ok, then 'electrical noise' from motors is causing interference with RF signal. 5.2c Move receiver and antenna a minimum of 6 feet from the motors. 5.2d If moving receiver 6 feet does not improve, an external antenna may be required to boost signal.
	5.3 Receiver logic power input is exposed to radiated noise from wire harness or motors	5.3a Disconnect receiver logic power input from main wire harness. 5.3b Run new wire from vehicle battery to red wire.
	5.4 Receiver logic ground is exposed to radiated noise from wire harness or motors	5.4a Disconnect receiver logic ground input from main wire harness. 5.4b Remove black wire on receiver from wire harness and install on the vehicle frame for a new chassis ground or vehicle battery. 5.4c Remove any paint or residue from metal, use an external tooth star washer and tighten new chassis ground terminal securely to vehicle frame.
	5.5 Transmitter 12-volt battery is low	5.5 Replace battery if voltage is 11.5 volts or below.
	5.6 Out of 25 foot range	5.6 Move closer to the vehicle.
	5.7 Interference	5.7a Electromagnetic interference (EMI) caused by any radio frequency (RF) nearby, motors, welding equipment, relays, etc. May be in close proximity to receiver / transmitter. 5.7b Move closer to antenna or move vehicle out of range of EMI caused by radio frequency, welding equipment, as this is a temporary problem. 5.7c If EMI is caused by relays, door motors or lift motors then the receiver must be moved or shielded or the EMI noise diverted to ground. Call the factory for details.
	5.8 Component of receiver damaged or defective	5.8 Send back to factory for repair or replacement.
	5.9 Other equipment installed in vehicle causing voltage drop when initially turning on	5.9 Remove all other equipment from logic ground and power.

Trouble Shooting Guide - K9 Partner door Opener

Symptom	Possible Cause	Corrective Action
6.0 Actuator not working	<p>6.1 No power or ground at actuator</p> <p>6.2 No power at door open relay output (#30)</p> <p>6.3 No signal from remote control</p> <p>6.4 No ground at safety disable switch</p> <p>6.5 Safety disable switch failed</p>	<p>6.1a Remove harness from actuator. Check voltage on green wire when button 'b' is pressed.</p> <p>6.1b If there is no voltage, check output #30.</p> <p>6.1c If there is voltage, then check ground to actuator.</p> <p>6.1d If voltage on green wire is 12vdc & ground is good, the actuator is defective or damaged. Send back to factory for replacement.</p> <p>6.1e Actuator can be damaged by leaving it in a 'locked rotor' position (fully extended and energized) for more than 5-seconds. This type of damage is NOT covered under warranty.</p> <p>6.2a Check voltage at #30 on door open relay when button 'b' is pressed. It should be +12vdc.</p> <p>6.2b If voltage is present on relay but NOT at actuator, there is a harness, terminal crimp or ground problem.</p> <p>6.3a Check voltage on pink wire at receiver output when button 'b' is pressed. It should be +12vdc.</p> <p>6.3b If there is no voltage, the output is damaged or defective. The output can be damaged by over current (more than 300mA) or using a test light to check voltage. The receiver should be returned to the factory for repair or replacement. Please note: This type of damage is NOT covered under warranty.</p> <p>6.4a Check ground at safety disable switch</p> <p>6.5a Disconnect safety disable switch. Using a volt meter check continuity at switch. If switch failed, call factory for a replacement switch.</p>
Symptom	Possible Cause	Corrective Action
7.0 Actuator needs to push, not pull	7.1 Actuator wires are reversed	7.1a Reverse power and ground wires on actuator outputs to change direction.

Trouble Shooting Guide - K9 Partner door Opener

Symptom	Possible Cause	Corrective Action
8.0 Actuator will not pull the latch open	8.1 Actuator does not have enough force to pull latch	<p>8.1a Install spring in parallel with actuator pull to enhance it.</p> <p>8.1b Shorten length of actuator travel distance to a maximum of 3/4". Any distance over 3/4" reduces pull force by one half.</p> <p>8.1c Install a pair of lever struts to improve the mechanical advantage of the pull and also to increase the travel distance of the pull.</p>
Symptom	Possible Cause	Corrective Action
9.0 Gas strut will not push the door open	<p>9.1 Angle of strut is correct</p> <p>9.2 Gas strut was installed with hydraulic grease at top of angle</p>	<p>9.1 Change mounting location and angle of gas strut to push the door open.</p> <p>9.2 Strut hydraulic gas / grease has drained from cylinder. This is considered customer damage and is NOT covered under warranty.</p>

TouchTronics, Inc. Warranty Policies and Procedures

The following revised warranty procedures will be implemented and effective March 1, 2002.

- 1) All products will now be shipped with an individual bar code attached.
- 2) The bar code will include some or all of the following information.
 - A) Date of Manufacture
 - B) Serial Number
 - C) Private Code
 - D) Part Number
- 3) Warranty Cards are no longer required to be eligible to receive technical support and service.
- 4) Each individual product is warranted under the TouchTronics Limited Warranty program for 1 full year from date of purchase or a *maximum* of 2 years from the date of manufacture.
- 5) No product will be covered under the TouchTronics Limited Warranty program that has a manufacture date older than 2 years.
- 6) To receive technical support or warranty service, simply call our technical support center during regular business hours.
- 7) To enable our technical support staff to better serve you, please have the following information available when you call.

Date Of:	
Manufacture	
Purchase	
Installation	

Vehicle Information:	
Dealer Name	
Dealer Phone	
Make / Model	

Product Information:	
Part Number	
Serial Number	
Private Code	

Please fill in all pertinent information at the time of purchase or installation

Limited One (1) Year Warranty

Section One

Seller will warranty any product originally manufactured and sold by seller for a period of 12 months (1 year) from the original retail sale or in-service date. It is the purchaser's responsibility to complete the warranty registration card and mail it to seller within thirty (30) days of the retail sale date. Seller will not warrant any product that does not have a warranty card on file with the seller's warranty department. Warranty card must be received within one year of the date of manufacture.

Section Two

The following are in lieu of all warranties, express, implied or statutory including but not limited to, any implied warranty of merchantability of fitness for a particular purpose and of any other warranty obligation on the part of seller. Sellers, except as otherwise hereinafter provided, warrant the goods against faulty workmanship or the use of defective materials for a period of one year.

Seller's sole and exclusive liability shall be (at seller's option) to repair, replace or credit buyer for and such goods which are returned by buyer during the applicable warranty period set forth above, provided that (I) seller is promptly notified in writing or phone upon discovery by buyer that such goods failed to conform and an explanation of any alleged deficiencies, (II) such goods are returned to seller, (III) seller's examination of such goods shall disclose that such alleged deficiencies actually exist and were not caused by accident, misuse, neglect, alteration, improper installation, unauthorized repair or improper testing. If seller elects to repair or replace such goods, seller shall have a reasonable time to make such repairs or replace such goods.

Seller's warranties as herein above set forth shall not be enlarged, diminished, or affected by, and no obligation or liability shall arise or grow out of, seller's rendering of technical advice or service.

Products damaged by the customer or during installation can not be claimed as a warranty. All devices returned that are not covered under the seller's warranty policy, will be charged a minimum of \$25.00 for evaluation plus additional charges for components and labor to repair the device not to exceed the original selling price. Seller considers the following to be typical examples of customer or installation damage: burned or broken traces on the printed circuit board, burned or damaged components, dirt or water residue on the printed circuit board or inside the case, modifications by the customer, broken cases or housings and dead batteries.

Section Three

A return material authorization number (RMA) must be issued by seller before any product is returned for evaluation or repair. Warranty repairs must be completed at authorized repair facilities.